

Produce high quality, delicious wrapped breads without damaging the dough.

COMPACT FN

STRESS FREE SYSTEM

Model Code : FN011

- Stretched dough is set on the upper conveyor of Compact FN before production. The filling is then discharged on to the dough, wrapped and carried out. Compact FN is fully automatic just by placing the dough. Sweet bean paste, curry bread and even more products can be easily molded.
- The filling depositing unit (depositor) can be switched on and off. The system can even wrap hand-deposited filling, and is ideal for small-quantity production. Specifications without a depositor are also available.



Compact FN (Right flow)



Anyone can produce these products easily and skillfully.



Curry Buns



Sweet Bean Paste Buns



Filled Yakisoba Bread



Danish with Crème D'amande

RHEON

Since Compact FN is mechanized based on hand-wrapping technology, it can improve production efficiency while maintaining quality.

Encrusting
Forming filled product
Wrap filling with the encruster.



Filling depositing
Deposits the filling on the dough.



Auto discharge after dough flattened.
Flattened dough is transferred to the Compact FN conveyor.



Place the dough ball
Place the dough ball on the Mini Gauge infeed conveyor.



The cylinder is made of stainless steel for great sanitation.

Dough Flow

Compact FN (Right flow)

Mini Gauge (Left insert type) / FR001(OPTION)
Dough Balls can be supplied by connecting Mini Gauge.

Equipped with a color touch panel for easy operation.



Illustrations make it easier to understand.



Put your foot under the equipment to alert the sensor to turn on.



Can be used in various ways to expand your product range.

Shut nozzle (optional) can stably deposit even fibrous ingredients.



Filled Kinpira Bread

Open top products can be produced by adjusting wrapping mechanism.



Curry Buns with Open Top

Place the pastry dough cut into a square shape to wrap the cream.



Danish Cream Buns

Place the sweet bean paste and chestnuts on the dough and wrap.



Sweet Bean Paste Bread with Chestnut

Wrap placed chestnuts in pie dough cut into square shape together with filling.



Chestnut Pie

Dimensions

(Unit : mm)

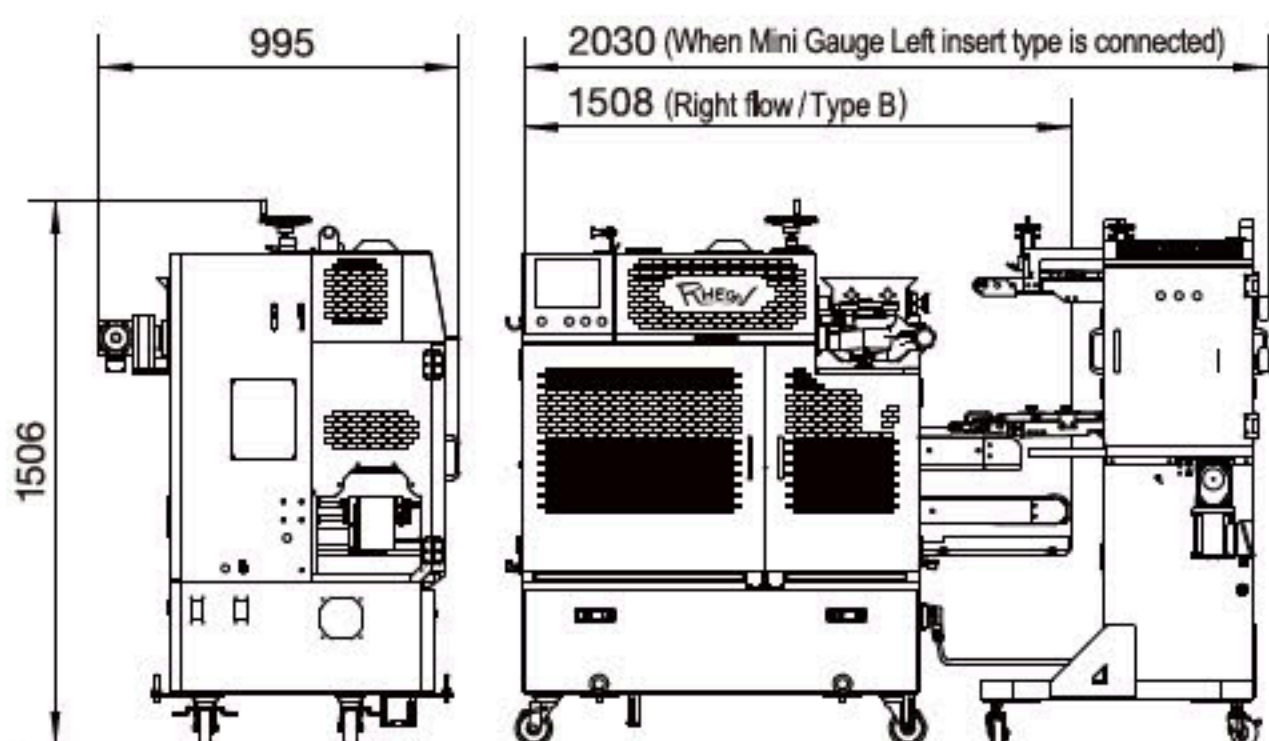

- Compact FN is also available with "Left flow type".
- Mini Gauge is also available with "Right insert type".

Specifications

Model Code	FN011	FR001
Length	2030mm (Mini Gauge Left insert type) 1508mm (Right flow / Type B)	884mm (Left insert type)
Depth	995 mm	503 mm
Height	1506 mm	1447 mm
Weight	500 kg	135 kg
Electric Capacity	1.22 kW	0.2 kW
Air	0.4Mpa, 200ℓ /min.	-
Hopper Capacity	15ℓ	-
Encrusting Capacity	※20pcs./min.(MAX)	-
Product Weight Range	※50~200g	-

※ Production speed and weight range varies depending on the material. Please make sure by running your own materials.

Product Example



Cheese Boule



Croquettey Buns



Fried Buns with pickled Nozawana and Mushrooms

The specifications are subject to change without notice and without obligation.
All Rights Reserved. Reproduction, adaptation or translation without prior written permission is prohibited.

RHEON

RHEON AUTOMATIC MACHINERY CO., LTD.
Head Office: 2-3 Nozawa-machi, Utsunomiya 320-0071, Japan
Phone: 028-665-1111 E-mail: info@rheon.com URL: https://www.rheon.com

RHEON U.S.A.
2 Doppler, Irvine, CA 92618, U.S.A.
Phone: 949-768-1900 E-mail: us.info@rheon.com URL: http://www.rheonusa.com

RHEON U.S.A. NJ BRANCH
700 Huyler Street Teterboro, NJ 07608, U.S.A.
Phone: 201-487-0600 E-mail: us.east@rheon.com

RHEON AUTOMATIC MACHINERY GmbH
Tiefenbroicher Weg 30, 40472 Düsseldorf, Germany
Phone: 0211-471950 E-mail: de.info@rheon.com URL: https://www.rheon-europe.com

RHEON AUTOMATIC MACHINERY GmbH ULM BRANCH
Saumweg 30, 89257 Illertissen, Germany
Phone: 07303-1599410 E-mail: ulm@rheon.com

RHEON AUTOMATIC MACHINERY CO., LTD. TAIWAN BRANCH
5F, No.118, Xinhua 1st Rd., Neihu District, Taipei City, Taiwan (R.O.C.)
Phone: 02-2792-3525 E-mail: tw.info@rheon.com

RHEON AUTOMATIC MACHINERY CO., LTD. SHANGHAI OFFICE
ROOM30, 5F GIFICII, 1438Hongqiao Road, changning District, Shanghai
Phone: 86-21-61976378 Fax: 86-21-61976380

© RHEON AUTOMATIC MACHINERY CO., LTD. 2020

No. S-FZFN-010-1A
20032000SK (英語)